

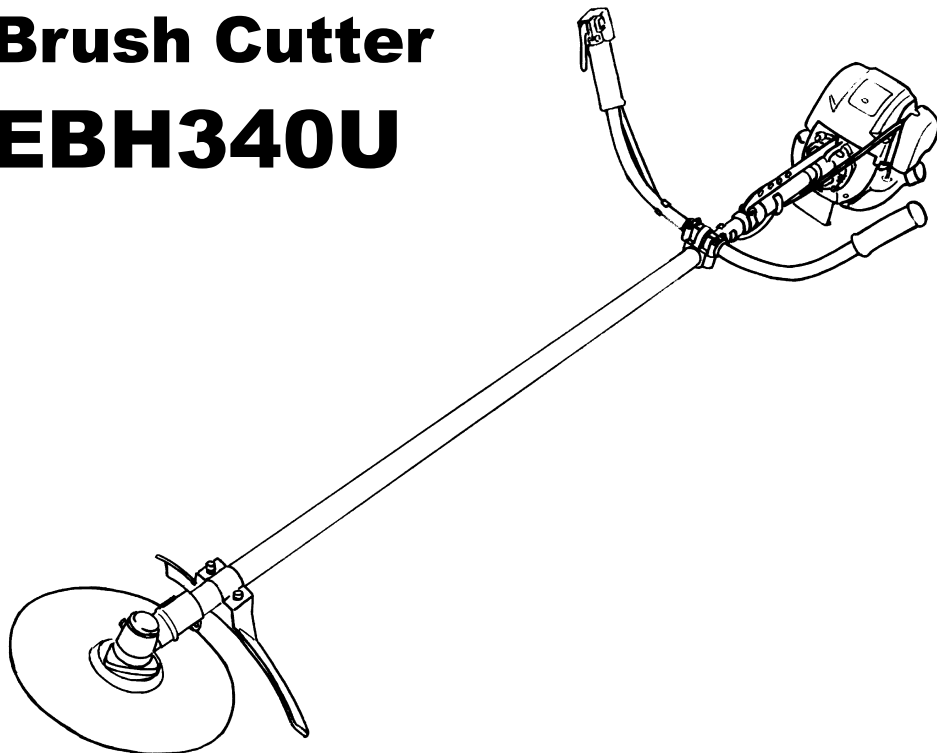

# Brush Cutter EBH340U



## INSTRUCTION MANUAL

---

**Important:**

Read this instruction manual carefully before putting the Brush Cutter into operation and strictly observe the safety regulations!



















Preserve instruction manual carefully!

Thank you very much for purchasing the MAKITA Brush Cutter. We are pleased to recommend to you the MAKITA Brush Cutter which is the result of a long development programme and many years of knowledge and experience. Please read this booklet which refers in detail to the various points that will demonstrate its outstanding performance. This will assist you to obtain the best possible result from your MAKITA Brush Cutter.

<b>Table of Contents</b>	<b>Page</b>
Symbols.....	3
Safety instructions .....	4
Technical data.....	9
Designation of parts.....	10
Assembly of engine and shaft.....	11
Mounting of handle .....	12
Mounting of control cable.....	13
Mounting of protector.....	14
Mounting of cutter blade .....	15
Before start of operation .....	16
Correct handling of machine.....	18
Points in operation and how to stop.....	18
Resharpener the cutting tool .....	20
Servicing instructions.....	21
Storage .....	25

# SYMBOLS

You will note the following symbols when reading the instructions manual.

	Read instruction Manual		Keep the area of operation clear of all persons and pets
	Take Particular care and Attention		Wear protective helmet, eye and ear protection
	Forbidden		Top permissible tool speed
	Keep distance		Fuel (Gasoline)
	Flying object hazard		Engine-Manual start
	No smoking		Emergency stop
	No open flame		First Aid
	Protective gloves must be worn		ON/START
	Wear sturdy boots with nonslip soles. Steeltoed safety boots are recommended.		OFF/STOP
	Kickback		

# SAFETY INSTRUCTIONS

## General Instructions

- To ensure correct operation, user has to read this instruction manual to make himself familiar with the handling of the Brush Cutter. Users insufficiently informed will risk danger to themselves as well as others due to improper handling.
- It is recommended only to lend the Brush Cutter to people who have proven to be experienced with Brush Cutter. Always hand over the instruction manual.
- First users should ask the dealer for basic instructions to familiarize oneself with the handling of an engine powered cutter.
- Children and young persons aged under 18 years must not be allowed to operate the Brush Cutter. Persons over the age of 16 years may however use the device for the purpose of being trained only whilst under supervision of a qualified trainer.
- Use Brush Cutter with the utmost care and attention.
- Operate the Brush Cutter only if you are in good physical condition. Perform all work calmly and carefully. The user has to accept liability for others.
- Never use the Brush Cutter after consumption of alcohol or drugs, or if feeling tired or ill.

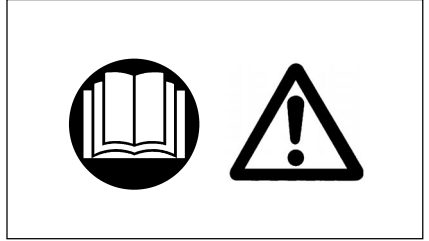

## Intended use of the machine

- The Brush Cutter is only intended for cutter grass, weeds, Bushes, undergrowth it should not be used for any other purpose such as Edging or hedge cutting as this may cause injury.

## Personal protective equipment

- The clothing worn should be functional and appropriate, i.e. it should be tight-fitting but not cause hindrance. Do not wear either jewelry or clothing which could become entangled with bushes or shrubs.
- In order to avoid either head-, eye-, hand- or foot injuries as well as to protect your hearing the following protective equipment and protective clothing must be used during operation of the Brush Cutter.
- Always wear a helmet where there is a risk of falling objects. The protective helmet (1) is to be checked at regular intervals for damage and is to be replaced at the latest after 5 years. Use only approved protective helmets.
- The visor (2) of the helmet (or alternatively goggles) protects the face from flying debris and stones. During operation of the Brush Cutter always wear goggles, or a visor to prevent eye injuries.
- Wear adequate noise protection equipment to avoid hearing impairment (ear muffs (3), ear plugs etc.).
- The work overalls (4) protect against flying stones and debris. We strongly recommend that the user wears work overalls.
- Special gloves (5) made of thick leather are part of the prescribed equipment and must always be worn during operation of the Brush Cutter.

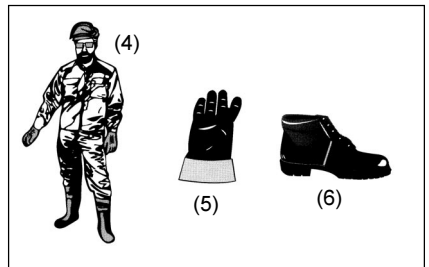
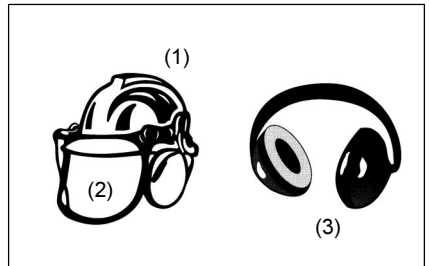

- When using the Brush Cutter, always wear sturdy shoes (6) with a non-slip sole. This protects against injuries and ensures a good footing.

## Starting up the brush cutter

- Please make sure that there are no children or other people within a working range of 15 meters (50ft), also pay attention to any animals in the working vicinity.
- Before use always check that the Brush Cutter is safe for operation:  
Check the security of the cutting tool, the control lever for easy action and check for proper functioning of the control lever lock.
- Rotation of the cutting tool during idling speed is not allowed. Check with your dealer for adjustment if in doubt. Check for clean and dry handles and test the function of the start/stop switch.

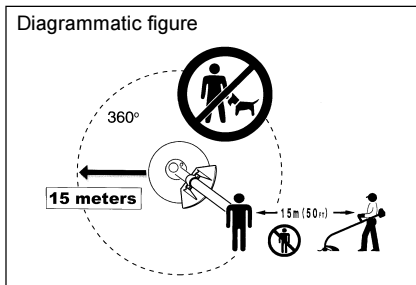

- Start the Brush Cutter only in accordance with the instructions.
- Do not use any other methods for starting the engine!
- Use the Brush Cutter and the tools only for such applications as specified.
- Only start the Brush Cutter engine, after the entire assembly is done. Operation of the device is only permitted after all the appropriate accessories are attached!
- Before starting make sure that the cutting tool has no contact with hard objects such as branches, stones etc. as the cutting tool will revolve when starting.
- The engine is to be switched off immediately in case of any engine problems.
- Should the cutting tool hit stones or other hard objects, immediately switch off the engine and inspect the cutting tool.
- Inspect the cutting tool at short regular intervals for damage (detection of hairline cracks by means of tapping-noise test).
- Operate the Brush Cutter only with the shoulder strap attached which is to be suitably adjusted before putting the Brush Cutter into operation. It is essential to adjust the shoulder strap according to the user's size to prevent fatigue occurring during use. Never hold the cutter with one hand during use.
- During operation always hold the Brush Cutter with both hands.  
Always ensure a safe footing.
- Operate the Brush Cutter in such a manner as to avoid inhalation of the exhaust gases. Never run the engine in enclosed rooms (risk of gas poisoning). Carbon monoxide is an odorless gas.
- Switch off the engine when resting and when leaving the Brush Cutter unattended, and place it in a safe location to prevent danger to others or damage to the machine.
- Never put the hot Brush Cutter onto dry grass or onto any combustible materials.
- The cutting tool has to be equipped with its appropriate guard.

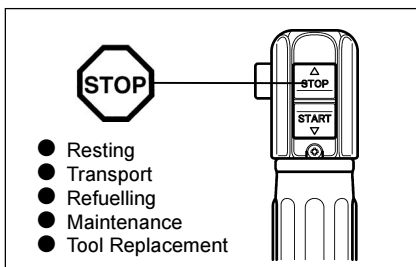
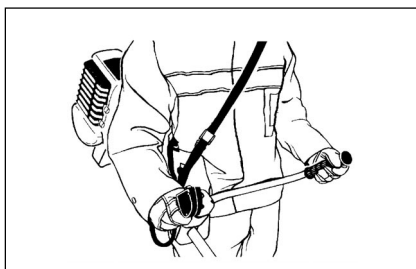
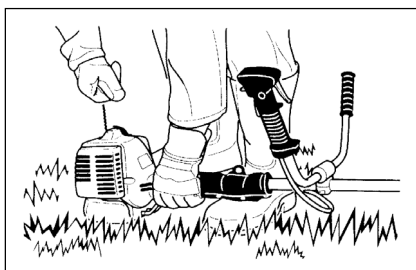

Never run the cutter without this guard!

- All protective installations and guards supplied with the machine must be used during operation.
- Never operate the engine with faulty exhaust muffler.
- Shut off the engine during transport.
- During transport over long distances the tool protection included with the equipment must always be used.
- Ensure safe position of the Brush Cutter during car transportation to avoid fuel leakage.
- When transporting the Brush Cutter, ensure that the fuel tank is completely empty.
- When unloading the Brush Cutter from the truck, never drop the Engine to the ground or this may severely damage the fuel tank.
- Except in case of emergency, never drop or cast the Brush Cutter to the ground or this may severely damage the Brush Cutter.
- Remember to lift the entire equipment from the ground when moving the equipment. Dragging the fuel tank is highly dangerous and will cause damage and leakage of fuel, possibly causing fire.

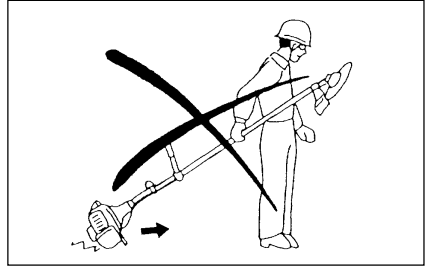

## Refuelling

- Shut off the engine during refuelling, keep away from open flames and do not smoke.
- Avoid skin contact with mineral oil products. Do not inhale fuel vapor. Always wear protective gloves during refuelling. Change and clean protective clothing at regular intervals.
- Take care not to spill either fuel or oil in order to prevent soil contamination (environmental protection). Clean the Brush Cutter immediately after fuel has been spilt.
- Avoid any fuel contact with your clothing. Change your clothing instantly if fuel has been spilt on it (to prevent clothing catching fire).
- Inspect the fuel cap at regular intervals making sure that it can be securely fastened and does not leak.
- Carefully tighten the fuel tank cap. Change location to start the engine (at least 3 meters away from the place of refuelling).
- Never refuel in closed rooms. Fuel vapors accumulate at ground level (risk of explosions).
- Only transport and store fuel in approved containers. Make sure the fuel stored is not accessible to children.

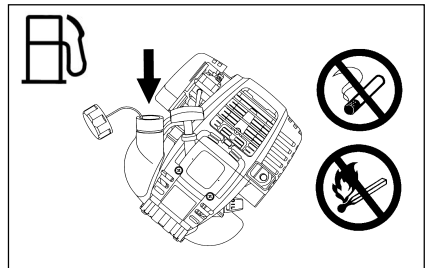
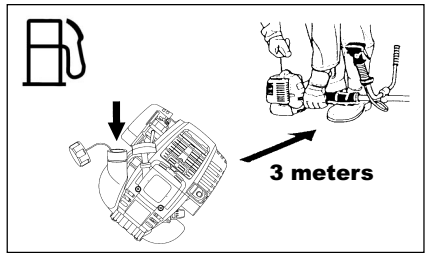

## Method of operation

- Only use the Brush cutter in good light and visibility. During the winter season beware of slippery or wet areas, ice and snow (risk of slipping). Always ensure a safe footing.
- Never cut above waist height.
- Never stand on a ladder and run the Brush cutter.
- Never climb up into trees to perform cutting operation with the Brush cutter.
- Never work on unstable surfaces.
- Remove sand, stones, nails etc. found within the working range.
- Foreign particles may damage the cutting tool and can cause dangerous kick-backs.
- Before commencing cutting, the cutting tool must have reached full working speed.



## Kickback

- When operating the brush cutter, uncontrolled kickback may occur.
- This is particularly the case when attempting to cut within a blade segment between 12 and 2 o'clock.
- Never apply the brush cutter within a segment between 12 and 2 o'clock.
- Never apply this segment of the brush cutter blade to solids, such as bushes and trees, etc., having a diameter in excess of 3 cm or the brush cutter will be deflected at great force with the risk of injuries.

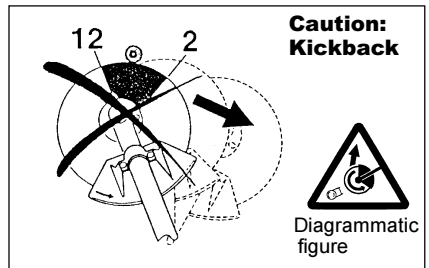

## Kickback prevention

### To avoid kickbacks, observe the following:

- Operation within a blade segment between 12 and 2 o'clock presents positive hazards, especially when using metal cutting tools.
- Cutting operations within a blade segment between 11 and 12 o'clock, and between 2 and 5 o'clock, must only be performed by trained and experienced operators, and then only at their own risk. Easy cutting with almost no kickback is possible within a blade segment between 8 and 11 o'clock.

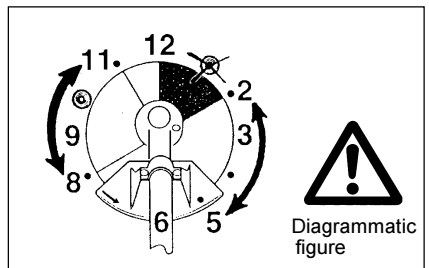

## Cutting Tools

Employ only the correct cutting tool for the job in hand.

For cutting thick materials, such as weed, high grass, bushes, shrubs, underwood, thicket etc. (max. 2 cm dia. thickness). Perform this cutting work by swinging the brush cutter evenly in half-circles from right to left (similar to using a scythe).

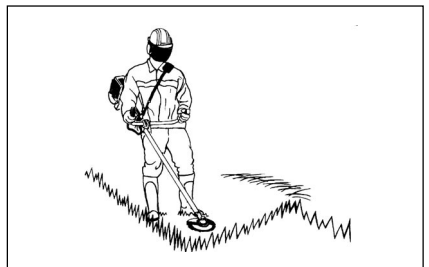

## Maintenance instructions

- The condition of the cutter, in particular of the cutting tool of the protective devices and also of the shoulder strap must be checked before commencing work. Particular attention is to be paid to the cutting blades which must be correctly sharpened.
- Turn off the engine and remove spark plug connector when replacing or sharpening cutting tools, and also when cleaning the cutter or cutting tool.

## Never straighten or weld damaged cutting tools.

- Operate the Brush cutter with as little noise and contamination as possible. In particular check the correct setting of the carburetor.
- Clean the Brush cutter at regular intervals and check that all screws and nuts are well tightened.
- Never service or store the Brush cutter in the vicinity of naked flames.
- Always store the Brush cutter in locked rooms and with an emptied fuel tank.



Observe the relevant accident prevention instructions issued by the relevant trade associations and by the insurance companies.

Do not perform any modifications on the Brush cutter as this will endanger your safety.

The performance of maintenance or repair work by the user is limited to those activities as described in the instruction manual. All other work is to be done by an Authorized Service Agent. Use only genuine spare parts and accessories released and supplied by MAKITA.

Use of non-approved accessories and tools means increased risk of accidents.

MAKITA will not accept any liability for accidents or damage caused by the use of non-approved cutting tools and fixing devices of cutting tools, or accessories.

## First Aid

In case of accident make sure that a first-aid box is available in the vicinity of the cutting operations. Immediately replace any item taken from the first aid box.

## When asking for help, please give the following information:

- Place of accident
- What happened
- Number of injured persons
- Kind of injuries
- Your name

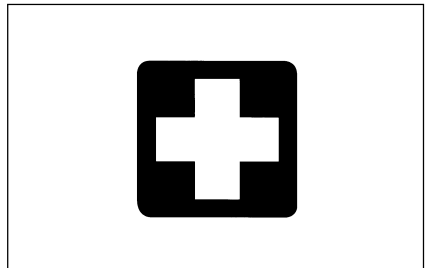



## TECHNICAL DATA

Model	EBH340U	
	U handle	
Dimensions : length x width x height (without cutting blade)	mm	1765 x 615 x 425
Mass (without plastic guard and cutting blade)	kg	7.5
Volume (fuel tank)	L	0.65
Cutting attachments (cutter blade dia.)	mm	305
Engine displacement	cm <sup>3</sup>	33.5
Maximum engine performance	kw	1.07 at 7000 min <sup>-1</sup>
Maximum rotational frequency of the spindle	min <sup>-1</sup>	6850
Engine speed at recommended max. spindle rotational frequency	min <sup>-1</sup>	10000
Fuel consumption at max. engine performance	kg/h	0.458
Specific fuel consumption at max. engine performance	g/kwh	426
Engine speed at idling	min <sup>-1</sup>	3000
Clutch engagement speed	min <sup>-1</sup>	4100
Carburetor (Diaphragm - carburetor)	type	WALBRO WYL
Ignition system	type	Solid state ignition
Spark plug	type	NGK CMR6A
Electrode gap	mm	0.7 - 0.8
Fuel		Automobile gasoline
Engine oil		SAE 10W-30 oil API Classification Class SF or higher (4-stroke engine for automobile)
Gear ratio		14/19

The data is prepared taking equally into account the idling and racing or wide-open throttle speed operating modes.

# DESIGNATION OF PARTS

## EBH340U Brush Cutter

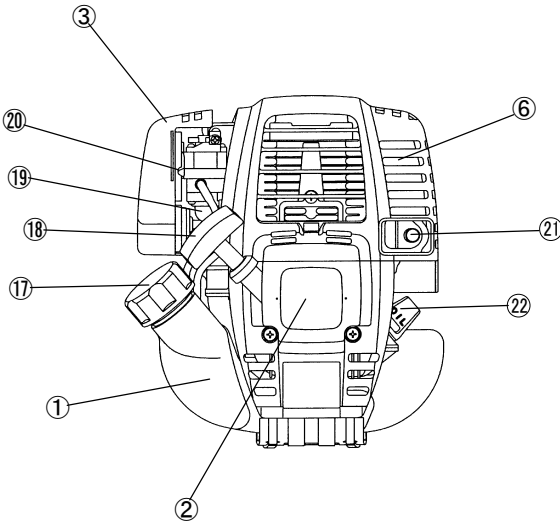
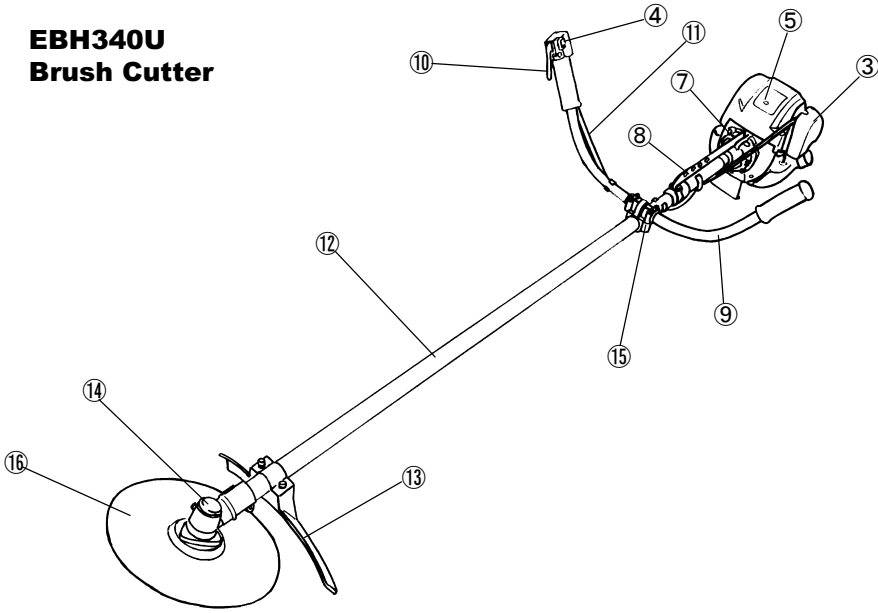

GB	DESIGNATION OF PARTS
1	Fuel Tank
2	Rewind Starter
3	Air Cleaner
4	I-O Switch (on/off)
5	Spark Plug
6	Exhaust Muffler
7	Clutch Case
8	Hanger
9	Handle
10	Throttle Lever
11	Control Cable
12	Shaft
13	Protector
14	Gear Case/Head Case
15	Handle Holder
16	Cutter Blade
17	Fuel Filler Cap
18	Starter Knob
19	Primer Pump
20	Choke Lever
21	Exhaust Pipe
22	Oil Gauge

## ASSEMBLY OF ENGINE AND SHAFT

CAUTION: Before doing any work on the brush cutter, always switch off the motor and pull the spark plug connector off the spark plug.  
Always wear protective gloves!



CAUTION: Start the brush cutter only after having assembled it completely.

– After checking the parts, fasten the drive shaft to the engine with four bolts M6 x 30 (1).

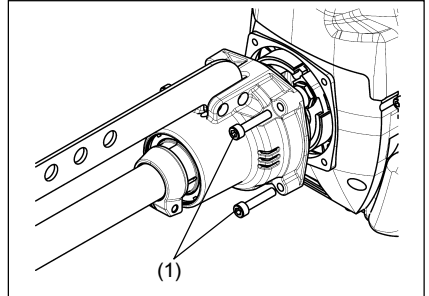

– Mount the stand by two screws M5 x 12 (2).

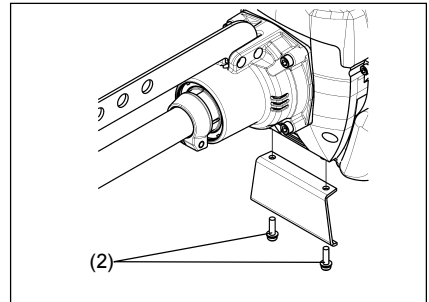

## MOUNTING OF HANDLE



- Place the handle with the throttle lever on the handle holder on the right side (to be held by the right hand) and the other on the left side.
- Fit the handle edge to the handle holder groove, and provisionally fix the upper side (3) of the handle holder by four bolts M5 x 25 (4).
- Adjust the handle to an angle easy to manipulate, and tighten the bolt (4) uniformly on the right and left sides.

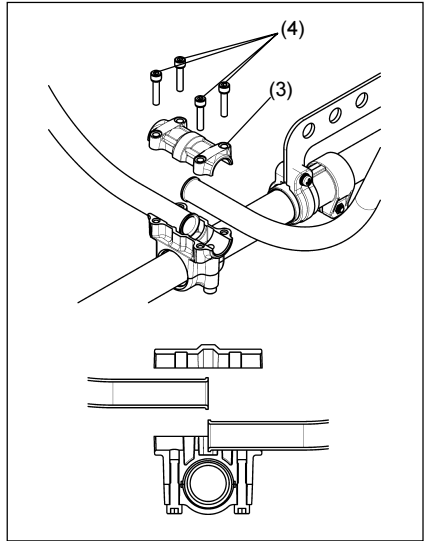

- Fix the control cable to the shaft by two clips (5).
- Fix the control cable to the handle by clip (6).

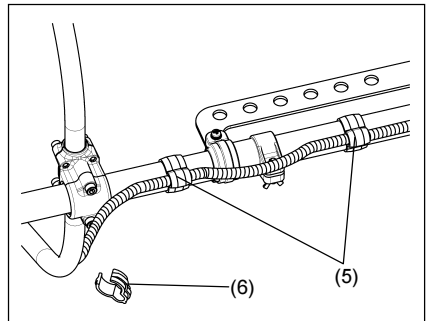

- The purpose of the detent lock is to prevent the engine from rotating relative to the drive shaft while operating the starter or transporting the equipment from place to place. The detent should be unlocked while the unit is being used.

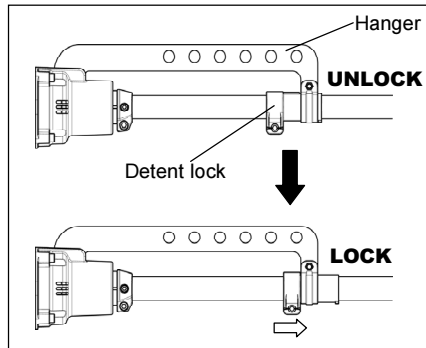

## MOUNTING OF CONTROL CABLE

- Remove the air cleaner cover.
- Place the control cable (1) in the adjusting bolt (2), and shift the swivel (3) so that the cable will be put in the swivel groove. At this time, the round-hole side of the swivel will be oriented toward the inner wire end-metal fitting.
- Release the swivel, and confirm that the inner wire-end metal fitting will be placed in the hole.
- Mount the air cleaner cover.

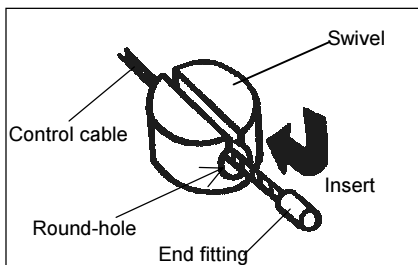
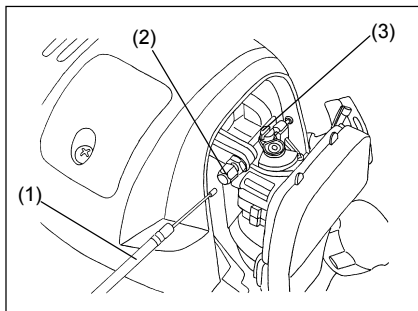

## CONNECTION OF SWITCH CORD

- Connect the switch cords to the two cords from the engine by inserting one into the other.
- Fix the cord connector by clamp (4).

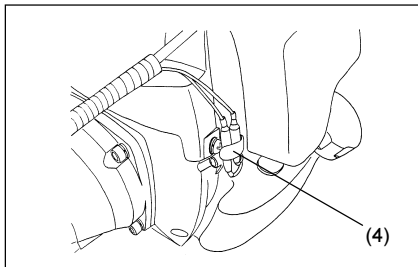

## ADJUSTMENT OF CONTROL CABLE

Adjust the control cable by adjusting bolt so that it will have 1 to 2 mm play when the throttle lever is set to the low-speed position by carburetor adjusting bolt. (Be careful that the cutter blade will not turn in idling.)

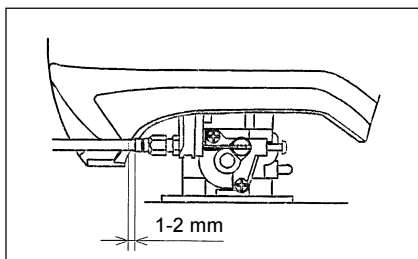

## MOUNTING OF PROTECTOR

- The cutter blade must be well polished, free of cracks or breakage. If the cutter blade hits against a stone during operation, stop the engine and check the blade immediately.
- Polish or replace the cutter blade every three hours of operation.



**CAUTION:** The appropriate protector must always be installed, for your own safety and in order to comply with accident-prevention regulations.

Operation of the equipment without the guard being in place is not permitted.

- The outside diameter of the cutter blade must be 305mm (12"). Never use any blades surpassing 305mm (12") in outside diameter.
- Fix the protector (1) to the clamp (3) with two bolts M6 x 20 (2).

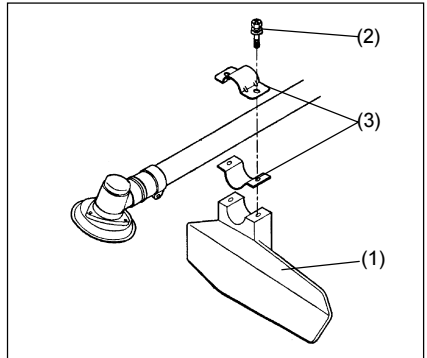

## MOUNTING OF CUTTER BLADE

Turn the machine upside down, and you can replace the cutter blade easily.

- Insert the hex wrench through the hole in the gear case and rotate the receiver washer (4) until it is locked with the hex wrench.
- Loosen the nut (1) (left-hand thread) with the socket wrench and remove the nut (1), cup (2), and clamp washer (3).

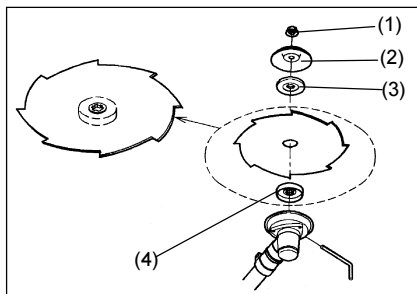

### Mounting of cutter blade

With the hex wrench still in place.

- Mount the cutter blade onto the shaft so that the guide of the receiver washer (4) fits in the arbor hole in the cutter blade. Install the clamp washer (3), cup (2), and secure the cutter blade with the nut (1).  
[Tightening torque: 13 - 23 N · m]

NOTE: Always wear gloves when handling the cutter blade.

NOTE: The cutter blade-fastening nut (with coned disc spring) is a consumable part.  
If there appears any wear or deformation on the coned disc spring, replace the nut.

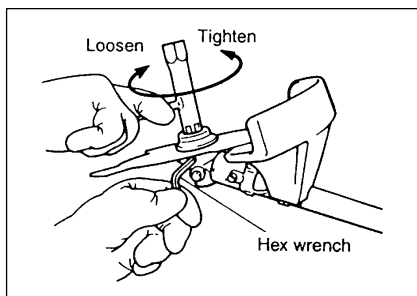

- Make sure that the blade is the left way up.

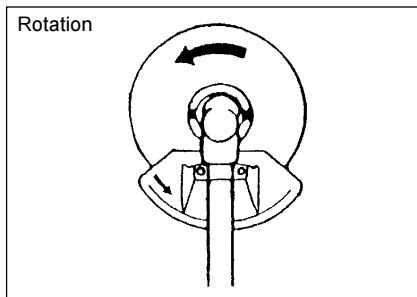

# BEFORE START OF OPERATION

## Inspection and Refill of Engine Oil

- Perform the following procedure, with the engine cooled down.
- While keeping the engine level, remove the oil gauge, and confirm that the oil is filled within the upper and lower limit marks.  
When the oil is in short in such a way that the oil gauge touches the oil only by its tip, in particular with the oil gauge remaining inserted in the crankcase without screwing-in (Fig. 1), refill new oil near the port (Fig. 2).
- For reference, the oil refill time is about 15 h (refill frequency: 15 times).
- If the oil changes in color or mixes with dirt, replace it with new one. (For the interval and method of replacement, refer to P. 21)

**Recommended oil:** SAE 10W-30 oil of API Classification, Class SF or higher (4-stroke engine for automobile)

**Oil volume:** Approx. 0.1 L

**Note:** If the engine is not kept upright, oil may go into around the engine, and may be refilled excessively. If the oil is filled above the limit, the oil may be contaminated or may catch fire with white.

### Point 1 in Replacement of Oil : “Oil Gauge”

- Remove dust or dirt near the oil refill port, and detach the oil gauge.
- Keep the detached oil gauge free of sand or dust. Otherwise, any sand or dust adhering to the oil gauge may cause irregular oil circulation or wear on the engine parts, which will result in troubles.
- As an example to keep the oil gauge clean, it is recommended to insert the oil gauge on its knob side into the engine cover, as shown in Fig.3.



Fig.1

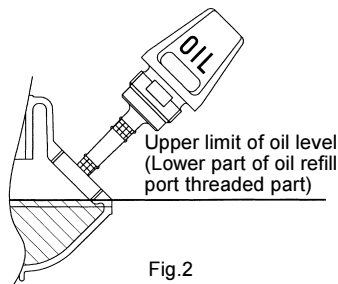

Fig.2

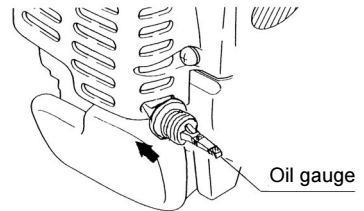
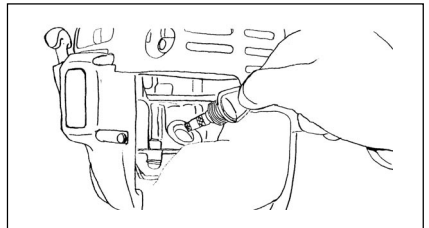

Fig.3

- (1) Keep the engine level, and detach the oil gauge.



- (2) Fill oil up to the edge of the oil refill port. (Refer to Fig.2). Feed oil with the lubricant refill container.

- (3) Securely tighten the oil gauge. Insufficient tightening may cause oil leakage.

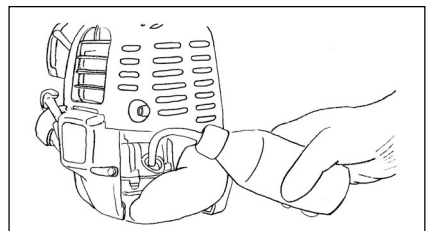



### Point 2 in Replacement of Oil: “If oil spills out”

- If oil spills out between the fuel tank and engine main unit, the oil is sucked into through the cooling air intake port, which will contaminate the engine. Be sure to wipe out spilt oil before start of operation.

## REFUELING

### Handling of Fuel

It is necessary to handle fuel with utmost care. Fuel may contain substances similar to solvents. Refueling must be performed in a sufficiently ventilated room or in the open air. Never inhale fuel vapor, and keep fuel away from you. If you touch fuel repeatedly or for a long time, the skin becomes dry, which may cause skin disease or allergy. If fuel enters into the eye, clean the eye with fresh water. If your eye remains still irritated, consult your doctor.

### Storage Period of Fuel

Fuel should be used up within a period of 4 weeks, even if it is kept in a special container in a well-ventilated shade.

If a special container is not used or if the container is not covered, fuel may deteriorate in one day.

### STORAGE OF MACHINE AND REFILL TANK

- Keep the machine and tank at a cool place free from direct sunshine.
- Never keep the fuel in the cabin or trunk.

### Fuel

The engine is a four-stroke engine. Be sure to use an automobile gasoline (regular gasoline or premium gasoline).

### Points for Fuel

- Never use a gasoline mixture which contains engine oil. Otherwise, it will cause excessive carbon accumulation or mechanical troubles.
- Use of deteriorated oil will cause irregular startup.

## Refueling

### WARNING: INFLAMMABLES STRICTLY PROHIBITED

**Gasoline used:** Automobile gasoline (unleaded gasoline)

- Loosen the tank cap a little so that there will be no difference in atmospheric pressure.
  - Detach the tank cap, and refuel, discharging air by tilting the fuel tank so that the refuel port will be oriented upward. (Never refill fuel full to the oil refill port.)
  - Wipe well the periphery of the tank cap to prevent foreign matter from entering into the fuel tank.
  - After refueling, securely tighten the tank cap.
- If there is any flaw or damage on the tank cap, replace it.
  - The tank cap is consumable, and therefore should be renewed every two to three years.

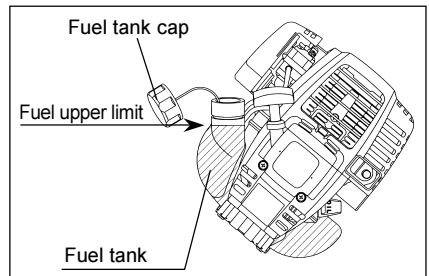

## CORRECT HANDLING OF MACHINE

### Attachment of shoulder strap

- Adjust the strap length so that the cutter blade will be kept parallel with the ground.

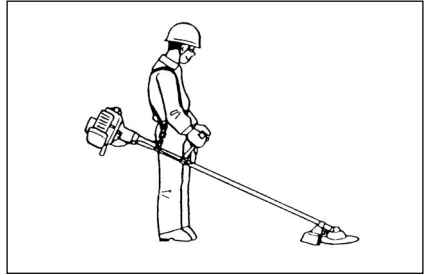

### Detachment

- In an emergency, pull the release belt (1) strongly upward, and you can detach the machine from you. Be extremely careful to maintain control of the machine at this time. Do not allow the machine to be deflected toward you or anyone in the work vicinity.

WARNING: Failure to maintain complete control of the machine at all could result in serious bodily injury or DEATH.

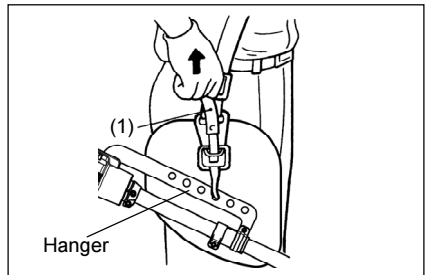

## POINTS IN OPERATION AND HOW TO STOP

Observe the applicable accident prevention regulations!



### STARTING

Move at least 3m away from the place of refuelling. Place the brush cutter on a clean piece of ground taking care that the cutting tool does not come into contact with the ground or any other objects.

### A: Cold start

- 1) Set this machine on a flat space.

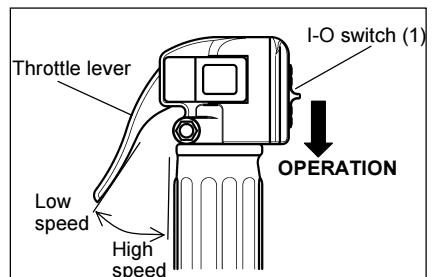

### For machine with U Handle or J Handle

- 1) Set the I-O switch (1) to OPERATION.
- 2) Choke lever  
Close the choke lever.  
Choke opening:
  - Full closing in cold or when the engine is cold.
  - Full or half opening in restart just after stop of operation.

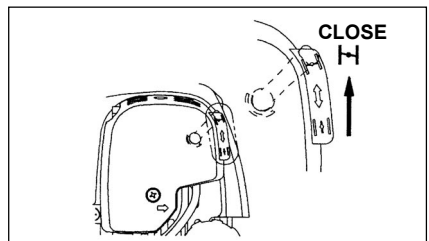

- 3) **Primer pump**  
 Continue to push the primer pump until fuel enters into the primer pump. (In general, fuel enters into the primer pump by 7 to 10 pushes.)  
 If the primer pump is pushed excessively, an excess of gasoline returns to the fuel tank.

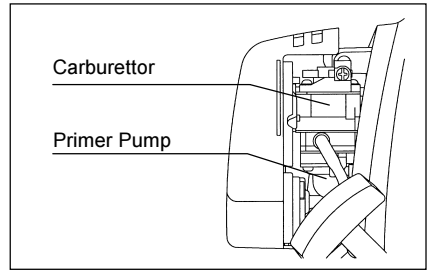

- 4) **Recoil starter**
- Pull the start knob gently until it is hard to pull (compression point). Then, return the start knob, and pull it strongly.
  - Never pull the rope to the full. Once the start knob is pulled, never release your hand immediately. Hold the start knob until it returns to its original point.

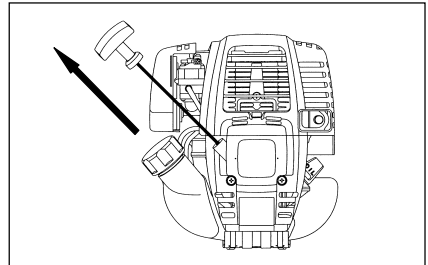

- 5) **Choke lever**  
 When the engine starts, open the choke lever.
- Open the choke lever progressively while checking the engine operation. Be sure to open the choke lever to the full in the end.
  - In cold or when the engine is cooled down, never open the choke lever suddenly. Otherwise, the engine may stop.

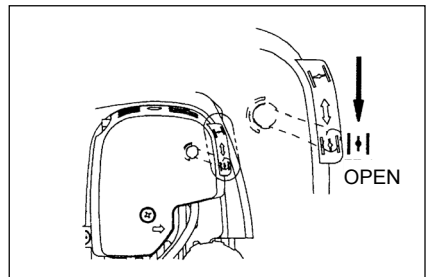

- 6) **Warm-up operation**  
 Continue warm-up operation for 2 to 3 minutes.

Note: - If the starter handle is pulled repeatedly when the choke lever remains at "START" position, the engine will not start easily due to excessive fuel intake.  
 - In case of excessive fuel intake, remove the spark plug and pull the starter handle slowly to remove excess fuel. Also, dry the electrode section of the spark plug.

### Caution during operation:

If the throttle lever is opened fully in a no-load operation, the engine rotation is increased to 10,000 min<sup>-1</sup> or more. Never operate the engine at a higher speed than required and at an approximate speed of 6,000 - 8,500 min<sup>-1</sup>.

### B: Startup after warm-up operation

- 1) Push the primer pump repeatedly.
- 2) Keep the throttle lever at the idling position.
- 3) Pull the recoil starter strongly.
- 4) If it is difficult to start the engine, open the throttle by about 1/3.  
 Pay attention to the cutter blade which may rotate.

### Attention in Operation

When the engine is operated upside down, white smoke may come out from the muffler.

## STOPPING

- 1) Release the throttle lever (6) fully, and when the engine rpm has lowered, set the I-O switch (1) to STOP the engine will now stop.
- 2) Be aware that the cutting head may not stop immediately and allow it to slow down fully.

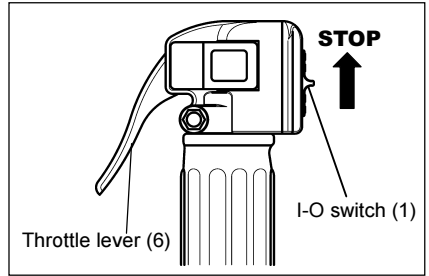

## ADJUSTMENT OF LOW-SPEED ROTATION (IDLING)

When it is necessary to adjust the low-speed rotation (idling), perform it by the carburetor adjusting screw.

### CHECKUP OF LOW-SPEED ROTATION

- Set the low-speed rotation to  $3000\text{min}^{-1}$ .  
If it is necessary to change the rotation speed, regulate the adjusting screw (illustrated on the left), with Phillips screwdriver.
- Turn the adjusting screw to the right, and the engine rotation will increase. Turn the adjusting screw to the left, and the engine rotation will drop.
- The carburetor is generally adjusted before shipment. If it is necessary to readjust it, please contact Authorized Service Agent.

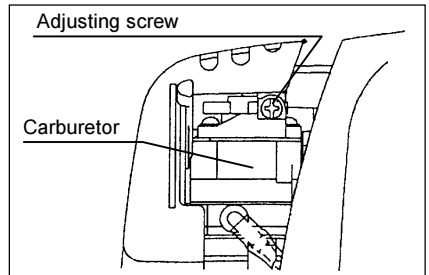

## RESHARPENING THE CUTTING TOOL

**CAUTION:** The cutting tools mentioned below must only be resharpened by an authorized facility. Manual resharpening will result in imbalances of the cutting tool causing vibrations and damage to the equipment.

- cutter blade (star blade (4 teeth), eddy blade (8 teeth))  
An expert resharpening and balancing service is provided by Authorized Service Agents.

**NOTE:** To increase the service life of the cutter blade (star blade, eddy blade) it may be turned over once, until both cutting edges have become blunt.

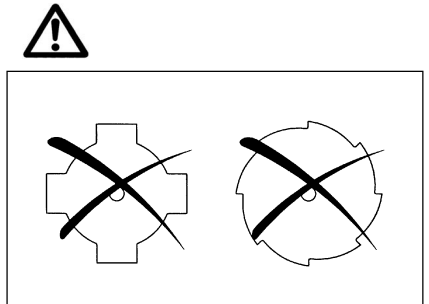

## SERVICING INSTRUCTIONS

**CAUTION:** Before doing any work on the brush cutter, always stop the engine and pull the plug cap off the spark plug (see "checking the spark plug"). Always wear protective gloves!

To ensure a long service life and to avoid any damage to the equipment, the following servicing operations should be performed at regular intervals.

### Daily checkup and maintenance

- Before operation, check the machine for loose screws or missing parts. Pay particular attention to the tightness of the cutter blade.
- Before operation, always check for clogging of the cooling air passage and the cylinder fins. Clean them if necessary.
- Perform the following work daily after use:
  - Clean the brush cutter externally and inspect for damage.
  - Clean the air filter. When working under extremely dusty conditions, clean the filter the several times a day.
  - Check the blade for damage and make sure it is firmly mounted.
  - Check that there is sufficient difference between idling and engagement speed to ensure that the cutting tool is at a standstill while the engine is idling (if necessary reduce idling speed). If under idling conditions the tool should still continue to run, consult your nearest Authorized Service Agent.
- Check the functioning of the I-O switch, the lock-off lever, the throttle lever.

### REPLACEMENT OF ENGINE OIL

Deteriorated engine oil will shorten the life of the sliding and rotating parts to a great extent. Be sure to check the period and quantity of replacement.



**ATTENTION:** In general, the engine main unit and engine oil still remain hot just after the engine is stopped. In replacement of oil, confirm that the engine main unit and engine oil are sufficiently cooled down. Otherwise, there may remain a risk of scald.

**Note:** If the oil filled above the limit, it may be contaminated or may catch fire with white smoke.

**Interval of replacement:** Initially, every 20 operating hours, and subsequently every 50 operating hours

**Recommended oil:** SAE10W-30 oil of API Classification SF Class or higher (4-stroke engine oil for automobile)

In replacement, perform the following procedure.

- 1) Confirm that the tank cap is tightened securely.
- 2) Detach the oil gauge.  
Keep the oil gauge free from dust or dirt.

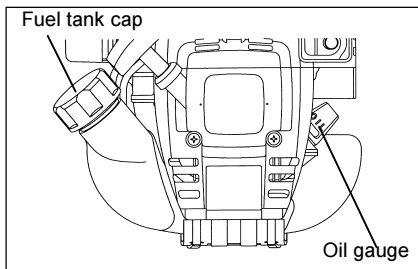

- 3) Place waste or paper near the oil refill port.

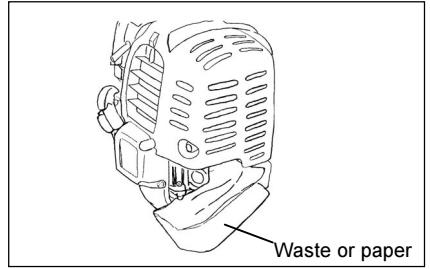

- 4) Detach the oil gauge, and drain oil, tilting the main unit toward the oil refill port.  
Drain oil in a container.

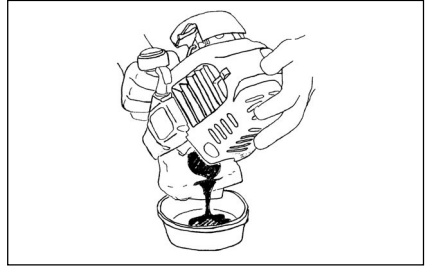

- 5) Keep the engine level, and feed new oil up to the edge of the oil refill port.  
In refill, use a lubricant refill container.
- 6) After refill, securely tighten the oil gauge. Insufficient tightening of the oil gauge will lead to oil leakage.

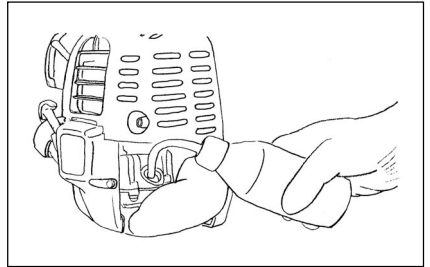

### POINTS ON OIL

- Never discard replaced engine oil in garbage, earth or sewage ditch. Disposal of oil is regulated by law. In disposal, always follow the relevant laws and regulations. For any points remaining unknown, contact Authorized Service Agent.
- Oil will deteriorate even when it is kept unused. Perform inspection and replacement at regular intervals (replace with new oil every 6 months).

## CLEANING OF AIR CLEANER



**DANGER: INFLAMMABLES STRICTLY PROHIBITED**

**Interval of Cleaning and Inspection: Daily (every 10 operating hours)**

- Turn the choke lever to the full close side, and keep the carburetor off from dust or dirt.
- Remove the air cleaner cover-fixing bolts.
- Pull the cover lower side and detach the air cleaner cover.
- If oil adheres to the element (sponge), squeeze it firmly.
- For heavy contamination:
  - 1) Remove the element (sponge), immerse it in warm water or in water-diluted neutral detergent, and dry it completely.
  - 2) Clean the element (felt) with gasoline, and dry it completely.
- Before attaching the element, be sure to dry it completely. Insufficient drying of the element may lead to difficult startup.
- Wipe out with waste cloth, oil adhering around the air cleaner cover and plate breather.
- Immediately after cleaning is finished, attach the cleaner cover and tighten it with fixing bolts. (In remounting, first place the upper claw, and then the lower claw.)

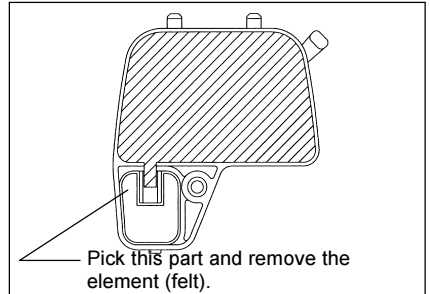
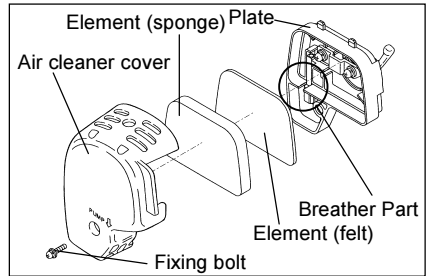

### Points in Handling Air Cleaner Element

- Clean the element several times a day, if excessive dust adheres to it.
- If operation continues with the element remaining not cleared of oil, oil in the air cleaner may fall outside, resulting in oil contamination.

## CHECKING THE SPARK PLUG

- Only use the supplied universal wrench to remove or to install the spark plug.
- The gap between the two electrodes of the spark plug should be 0.7-0.8mm (0.028"-0.032"). If the gap is too wide or too narrow, adjust it. If the spark plug is clogged with carbon or fouled, clean it thoroughly or replace it.

**CAUTION:** Never touch the spark plug connector while the engine is running (danger of high voltage electric shock).

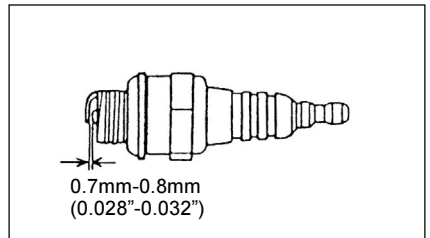

## SUPPLY OF GREASE TO GEAR CASE

- Supply grease (Shell Alvania 2 or equivalent) to the gear case through the grease hole every 30 hours. (Genuine MAKITA grease may be purchased from your MAKITA dealer.)

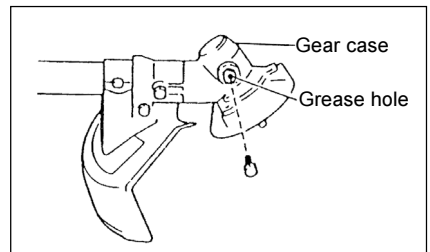

## CLEANING OF FUEL FILTER

### WARNING: INFLAMMABLES STRICTLY PROHIBITED

Interval of Cleaning and Inspection: Monthly (every 50 operating hours)

#### Suction head in the fuel tank

- The fuel filler (1) of the suction head is used to fill the fuel required by the carburetor.
- A periodical visual inspection of the fuel filter is to be conducted. For that purpose open the tank cap, use a wire hook and pull out the suction head through the tank opening. Filters found to have hardened, been polluted or clogged up are to be replaced.
- Insufficient fuel supply can result in the admissible maximum speed being exceeded. It is therefore important to replace the fuel filter at least quarterly to ensure satisfactory fuel supply to the carburetor.

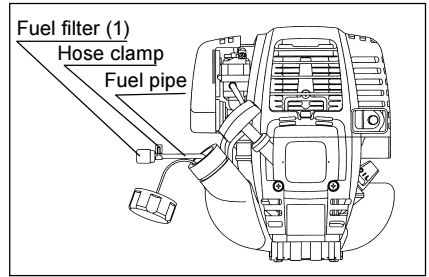

## REPLACEMENT OF FUEL PIPE

### CAUTION: INFLAMMABLES STRICTLY PROHIBITED

Interval of Cleaning and Inspection: Daily (every 10 operating hours)

Replacement: Annually (every 200 operating hours)

Replace the fuel pipe every year, regardless of operating frequency. Fuel leakage may lead to fire.

If any leakage is detected during inspection, replace the oil pipe immediately.

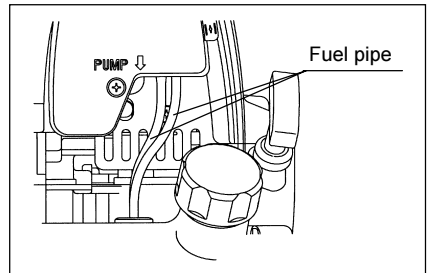

## INSPECTION OF BOLTS, NUTS AND SCREWS

- Retighten loose bolts, nuts, etc.
- Check for fuel and oil leakage.
- Replace damaged parts with new ones for safety operation.

## CLEANING OF PARTS

- Keep the engine always clean.
- Keep the cylinder fins free of dust or dirt. Dust or dirt adhering to the fins will cause seizure.

## REPLACEMENT OF GASKETS AND PACKINGS

In reassembling after the engine is dismantled, be sure to replace the gaskets and packings with new ones. Any maintenance of adjustment work that is not included and described in this manual is only to be performed by Authorized Service Agents.



## STORAGE



**WARNING:** When draining the fuel, be sure to stop the engine and confirm that the engine cools down.

Just after stopping the engine, it may still hot with possibility of burns, inflammability and fire.



**ATTENTION:** When the machine is kept out of operation for a long time, drain up all fuel from the fuel tank and carburetor, and keep it at a dry and clean place.

- Drain up fuel from the fuel tank and carburetor according to the following procedure:
  - 1) Remove the fuel tank cap, and drain fuel completely.  
If there is any foreign matter remaining in the fuel tank, remove it completely.
  - 2) Pull out the fuel filter from the refill port using a wire.
  - 3) Push the primer pump until fuel is drained from there, and drain fuel coming into the fuel tank.
  - 4) Reset the filter to the fuel tank, and securely tighten the fuel tank cap.
  - 5) Then, continue to operate the engine until it stops.
- Remove the spark plug, and drip several drops of engine oil through the spark plug hole.
- Gently pull the starter handle so that engine oil will spread over the engine, and attach the spark plug.
- Attach the cover to the cutter blade.
- During storage, keep the rod horizontal or keep the machine upright with the blade edge oriented upward. (In this case, pay full attention to prevent the machine from falling.)  
Never store the machine with the cutter blade edge oriented downward. Lubricating oil may spill out.
- Keep the drained fuel in a special container in a well-ventilated shade.

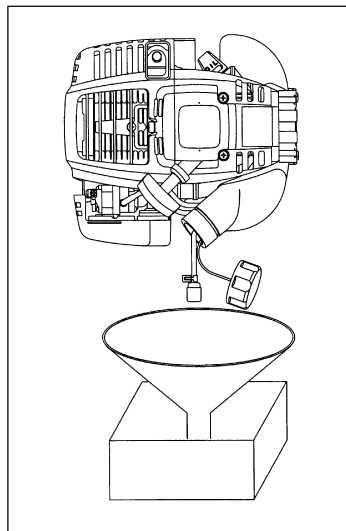

### Attention after long-time storage

- Before startup after long-time shutdown, be sure to replace oil (refer to P 21). Oil will deteriorate while the machine is kept out of operation.

## Fault location

Fault	System	Observation	Cause
Engine not starting or with difficulty	Ignition system	Ignition spark O.K.	Fault in fuel supply or compression system, mechanical defect
		No ignition spark	STOP-switch operated, wiring fault or short circuit, spark plug or connector defective, ignition module faulty
	Fuel supply	Fuel tank filled	Incorrect choke position, carburetor defective, fuel supply line bent or blocked, fuel dirty.
	Compression	No compression when pulled over	Cylinder bottom gasket defective, crankshaft seals damaged, cylinder or piston rings defective or improper sealing of spark plug
Warm start problems	Mechanical fault	Starter not engaging	Broken starter spring, broken parts inside of the engine
		Tank filled ignition spark existing	Carburetor contaminated, have it cleaned
Engine starts but dies	Fuel supply	Tank filled	Incorrect idling adjustment, carburetor contaminated  Fuel tank vent defective, fuel supply line interrupted, cable or STOP-switch faulty
Insufficient performance	Several systems may simultaneously be affected	Engine idling poor	Air filter contaminated, carburetor contaminated, muffler clogged, exhaust duct in the cylinder clogged

Operating time Item		Before operation	After lubrication	Daily (10h)	30h	50h	200h	Shutdown /rest	Corres- ponding P
Engine oil	Inspect/ clean	○							16
	Replace					○*1			21
Tightening parts (bolt, nut)	Inspect	○							24
Fuel tank	Clean/ inspect	○							—
	Drain fuel							○*3	25
Throttle lever	Check function		○						18
Stop switch	Check function		○						18
Cutting blade	Inspect	○		○					15
Low-speed rotation	Inspect/ adjust			○					20
Air cleaner	Clean			○					23
Ignition plug	Inspect			○					23
Cooling air duct	Clean/ inspect			○					24
Fuel pipe	Inspect			○					24
	Replace						◎*2		—
Gear-case grease	Refill				○				23
Fuel filter	Clean/ replace					○			24
Clearance between air intake valve and air discharge valve	Adjust						◎*2		—
Oil tube	Inspect						◎*2		
Engine overhaul							◎*2		—
Carburetor	Drain fuel							○*3	25

\*1 Perform initial replacement after 20h operation.

\*2 For the 200 operating hour inspection, request Authorized Service Agent or a machine shop.

\*3 After emptying the fuel tank, continue to run the engine and drain fuel in the carburetor.

## TROUBLESHOOTING

Before making a request for repairs, check a trouble for yourself. If any abnormality is found, control your machine according to the description of this manual. Never tamper or dismount any part contrary to the description. For repairs, contact Authorized Service Agent or local dealership.

State of abnormality	Probable cause (malfunction)	Remedy
Engine does not start	Failure to operate primer pump	Push 7 to 10 times.
	Low pulling speed of starter rope	Pull strongly.
	Lack of fuel	Feed fuel.
	Clogged fuel filter	Clean
	Broken fuel tube	Straighten fuel tube
	Deteriorated fuel	Deteriorated fuel makes starting more difficult. Replace with new one. (Recommended replacement: 1 month)
	Excessive suction of fuel	Set throttle lever from medium speed to high speed, and pull starter handle until engine starts. <b>Once engine starts, cutter blade starts rotating. Pay full attention to cutter blade.</b> If engine will not start still, remove spark plug, make electrode dry, and reassemble them as they originally are. Then, start as specified.
	Detached plug cap	Attach securely
	Contaminated spark plug	Clean
	Abnormal clearance of spark plug	Adjust clearance
	Other abnormality of spark plug	Replace
	Abnormal carburetor	Make request for inspection and maintenance.
	Starter rope cannot be pulled	Make request for inspection and maintenance
Abnormal drive system	Make request for inspection and maintenance	
Engine stops soon Engine speed does not increase	Insufficient warm-up	Perform warm-up operation
	Choke lever is set to "CLOSE" although engine is warmed up	Set to "OPEN"
	Clogged fuel filter	Clean
	Contaminated or clogged air cleaner	Clean
	Abnormal carburetor	Make request for inspection and maintenance
	Abnormal drive system	Make request for inspection and maintenance

State of abnormality	Probable cause (malfunction)	Remedy
Cutter blade does not rotate ↓ Stop engine immediately	Loosened cutter blade-tightening nut	Tighten securely
	Twigs caught by cutter blade or dispersion-preventing cover	Remove foreign matter
	Abnormal drive system	Make request for inspection and maintenance.
Main unit vibrates abnormally. ↓ Stop engine immediately	Broken, bent or worn cutter blade	Replace cutter blade
	Loosened cutter blade-tightening nut	Tighten securely
	Shifted convex part of cutter blade and cutter blade support fitting	Attach securely
	Abnormal drive system	Make request for inspection and maintenance
Cutter blade does not stop immediately. ↓ Stop engine immediately	High idling rotation	Adjust
	Detached throttle wire	Attach securely
	Abnormal drive system	Make request for inspection and maintenance
Engine does not stop. ↓ Run engine at idling, and set choke lever to CLOSE.	Detached connector	Attach securely
	Abnormal electric system	Make request for inspection and maintenance.

When the engine does not start after warm-up operation:

If there is no abnormality found for the check items, open the throttle by about 1/3 and start the engine.

---

# MEMO

---

# MEMO

**Makita Corporation**

Anjo, Aichi, Japan

885002-5

[www.makita.com](http://www.makita.com)